

Introduction

Fonctionalities

With Solve Elec you can :

- draw a circuit
- modify the properties of circuit components
- define quantities related to the circuit by their formulas
- see the circuit solution including literal formulas of quantities defined by meters
- verify circuit related equations
- draw graphs
- make a report containing various elements displayed in main window

The version 2.0 of Solve Elec allow you to study circuits in direct current.

Solve Elec Window

Main tools --->

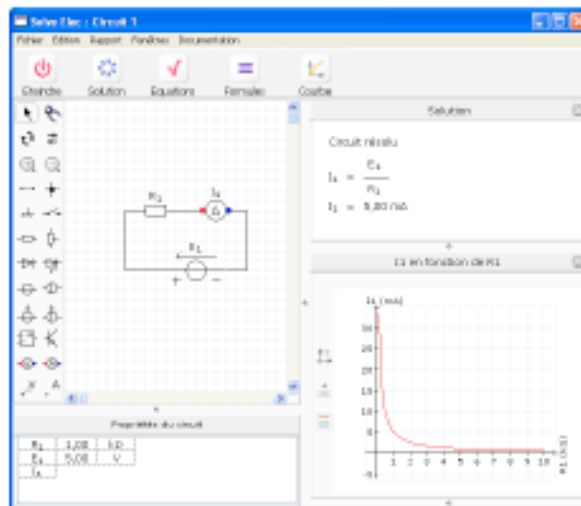

Left column

Right column

Solve Elec window represents an electricity working station, it is divided in three parts.

- The upper part contains various buttons to switch the circuit on and off and open different instruments as needed.
- The left column always shows two instruments to draw the circuit and change circuit properties.
- The right column shows instruments opened by a click on a button of the main tool bar. Those instruments can be closed by a click on their close button. When the circuit is on, the instruments displays are automatically updated each time a circuit property is changed.

The instruments dimensions can be modified by dragging the separators between them or by resizing the window.

Circuit drawing

The circuit is drawn and modified with the tools displayed in the box on the left of the drawing. The circuit is automatically switched off when it is modified.

Adding a component

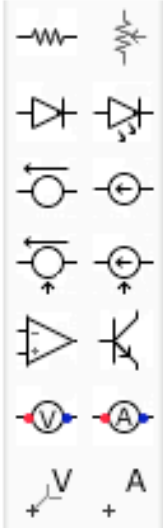

- Click a component displayed in the left box, move the mouse and click inside the drawing on the location where you want to insert the component.
- Type r on the keyboard to rotate the component before inserting it in the drawing.
- The component won't be inserted if there is not enough room for it around the clicked location. Components and wires can't overlay each other.

Drawing and modifying wires

Adding a wire



- Choose wire tool and drag the mouse on the circuit to draw a new wire.
- The wires are horizontal or vertical.

Changing a wire length

- Select the wire and drag one of its endings

Contact between to crossing wires



Crossing wires without electrical contact



Crossing wires with electrical contact

- By default two crossing wires have no electrical contact.
- Choose contact tool and click the intersection point of two wires to add or remove a contact

Selecting drawing elements



Click selection tool to select one or more elements in the drawing.

Selecting one element

- Click the element with select tool.
- To select a component, you can also click one of its properties displayed in the circuit properties below the drawing.
- A selected element is drawn in blue. If it is a component, its properties are also selected in the circuit properties.

Selecting several elements

- Drag the mouse over the drawing to select several elements.
- Choose menu Edit > Select all to select all the elements of the drawing.

Deselecting selected elements

- Click an empty location in the drawing with selection tool.

Moving elements

- Select one or several elements and drag the selection
- You can also use the keyboard arrow keys to move the selected elements.
- In case the moved selection overlays another part of the drawing, the move is cancelled, the selection is redrawn at its initial location.

Rotating a component

Components may be drawn horizontally or vertically, except the ground and the amplifier.

Before inserting the component

- Click on the desired component in the tool box, move the mouse to the drawing, type `r` on the keyboard to rotate it.

After inserting the component



- Click rotation tool, then click the component in the drawing. The rotation is done only if after rotation the component doesn't overlay other parts of the drawing.

You can also use the rotation tool to make the notation of a point or a potential rotate around its position by clicking the notation.



Reversing component terminals



- Click the component with the reverse tool to reverse its terminals

- The reverse tool has no effect on non polarized components like resistors and potentiometers

Example :

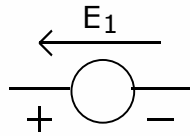

Voltage source
before reversing

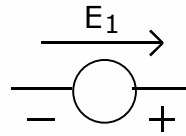

Voltage source
after reversing

- You can also set a switch on or off by clicking it with the reverse tool

Removing elements from the drawing

With the eraser



- Choose eraser tool and click the element to be removed .

With the keyboard

- Select the element(s) to be removed and press the delete key

Changing drawing scale

The circuit can be displayed with four different scales



- Click zoom + button to enlarge the drawing.
- Click zoom - button to reduce the drawing.

Using the clipboard

Copy

- Select drawing elements to be copied
- Select menu Edit > Copy
- The elements are stored in the clipboard and they remain in the drawing.

Cut

- Select drawing elements to be cut
- Select menu Edit > Cut
- The elements are stored in the clipboard and they are removed from the drawing.

Coller

- Select menu Edit > Paste.
- The clipboard content is pasted at the last clicked position in the drawing, if there is enough room for it.

Drawing norm

- The circuit can be drawn with the US or the European norm
- The norm can be changed in Solve Elec Preferences

Circuits files

Save and open

Menu File > Save

Menu File > Save as...

Choose these menus to save the circuit in a file

Menu File > Open

Choose this menu to open a circuit.

The previous circuit is replaced by the opened one.

Exportation and importation

Menu File > Export

Choose this menu to save the selected part of the circuit in a file.

The exported file is different from the saved file, but has the same file format.

Menu File > Import

Choose this menu to import a circuit part inside the current circuit.

The imported circuit is added to the current circuit at the last clicked position, if possible

The notations of the imported circuit which are already used in the current circuit are modified to avoid having different components with the same notation.

You can quickly build a complex circuit by importing its parts from files.

Circuit elements

Components

Components properties

- Each component is described by a set of properties : notation(s), values(s) and unit(s), etc ... Those properties are displayed in the circuit properties list, below the drawing. When a component is selected in the drawing, the line showing its properties is also selected. When the mouse is over a property, the description of this property is displayed above the properties list.
- All the properties may be changed. For instance, to change a resistor value, click the cell containing this value, type the new value followed by the return key to validate the change.
- When a property is modified, the window display is updated. For instance, a displayed graph is automatically recomputed for the new value and redrawn.

Notations

- The first property of each component is its notation. It represents a typical quantity of the component or the name given to the component (for a switch, a diode, an amplifier and a transistor). Each component notation is displayed in the drawing and in the first column of the circuit properties list. Examples : E1 is the electromotive force of a voltage source, A1 is the name of an amplifier.
- To change a component notation, click the cell containing this notation and type the new notation
- A notation must begin with a letter, following characters must be letters or digits.
- Two components of the same kind may share the same notation, except switches, diodes, amplifiers and transistors. For instance two voltage source can have the same electromotive force E, but two transistors can't have the same name T.

Numerical values

- To change the numerical value of a quantity, click the cell containing this value and type the new value.
- The number of significant digits used to display the numerical values can be changed in Solve Elec preferences.

Components description

Switch



Switch off.

The intensity of the current through the switch is zero.

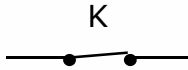

Switch on.

The voltage across the switch is zero.

Click the component with the reverse tool to switch it on or off.

Resistor

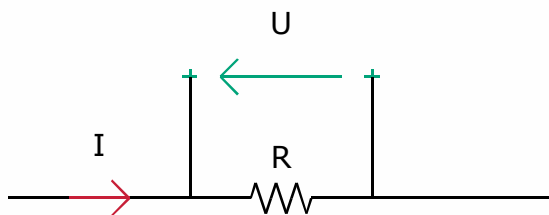

Ohm's law

$$U = R I$$

Potentiometer

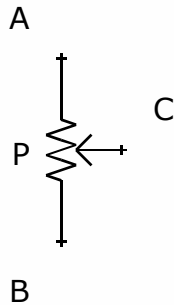

- P is the total resistance of the potentiometer measured between A and B

- x represents the swiper position.
x value is between 0 and 1

Potentiometer equivalent drawing :

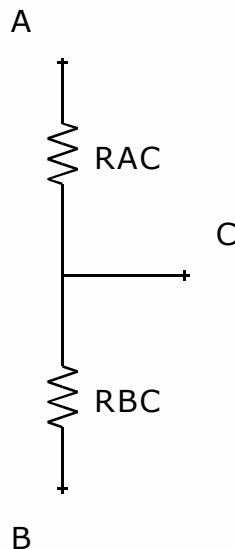

The resistance between A and C terminals is :

$$R_{AC} = P x$$

The resistance between B and C terminals is :

$$R_{BC} = P (1 - x)$$

Diode

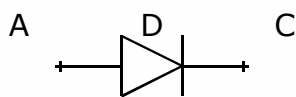

D is the name of the diode.

A is the anode, C is the cathode.



V_d is the diode threshold voltage.

By default $V_d = 0,6 \text{ V}$

States of the diode :

Diode off :

- the current intensity flowing through the diode is zero.
- the voltage across its terminals is below the threshold : $U_{AC} < V_d$

Diode on :

- the current flows from anode towards cathode
- the voltage across its terminals is equal to the threshold : $U_{AC} = V_d$

Ideal diode :

To simulate an ideal diode, set its threshold value to 0 V

Light emitting diode (LED)

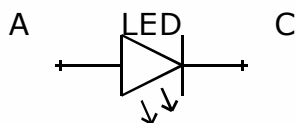

V_l is the LED threshold voltage.

The value of the threshold depends on the color of the light emitted by the diode.



Electrical functioning of the LED is identical to the diode functioning.

Voltage source

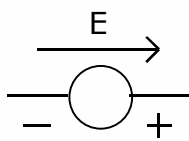

E is the electromotive force of the source.

The source supplies a fixed potential difference across its terminals that is completely independent of the current it supplies

Two voltage sources can be connected in serial but not in parallel.

Current source

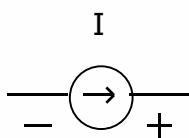

I is the intensity of the current supplied by the source.

The source supplies a fixed intensity that is completely independent of the voltage across its terminals.

Two current sources can be connected in parallel but not in serial.

Controlled voltage source

A controlled voltage source supplies a voltage proportional to a voltage or a current of the circuit.

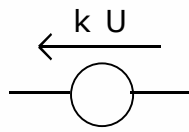

Voltage source controlled by another voltage U of the circuit.

The source electromotive force is :
 $E = k U$

k is the control constant notation.
The value of k has no unit

U is the control voltage, it is another voltage which must be defined in the drawing by a voltmeter.

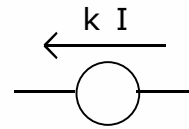

Voltage source controlled by a current intensity I of the circuit.

The source electromotive force is :
 $E = k I$

k is the control constant notation.
The value of k is in V / A

I is the control current intensity, it must be defined in the drawing by an ammeter.

Controlled current source

A controlled current source supplies a current of intensity proportional to a voltage or current of the circuit.

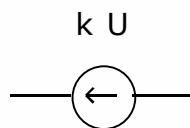

Current source controlled by a voltage U of the circuit.

The source intensity current is :
 $I_s = k U$

k is the control constant notation.
The value of k is in A / V

U is the control voltage, it is a voltage which must be defined in the drawing by a voltmeter.

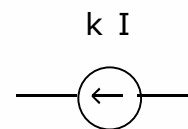

Current source controlled by a current intensity I of the circuit.

The source intensity current is :
 $I_s = k I$

k is the control constant notation.
The value of k has no unit.

I is the control current intensity, it must be defined in the drawing by an ammeter.

Operational amplifier

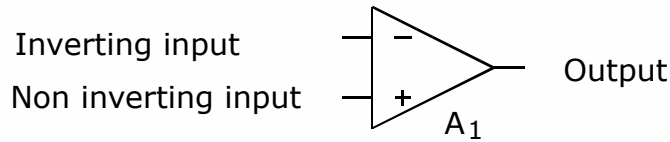

- A₁ is the amplifier name, it is displayed in the drawing.
- The amplifier DC supplies are not drawn, but are considered as being connected when the circuit is analyzed.
- Saturation voltages notations and default values :
 - high saturation $V_{satH} = 15\text{ V}$
 - low saturation $V_{satL} = -15\text{ V}$Saturation voltages values can be changed, V_{satH} must be larger than V_{satL}
- Solve Elec uses the model of the ideal operational amplifier when analyzing the circuit :
- the input currents are zero.
- in linear functioning, the differential input voltage is zero.

Transistor

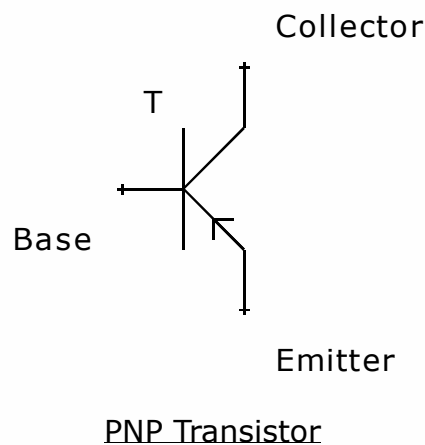
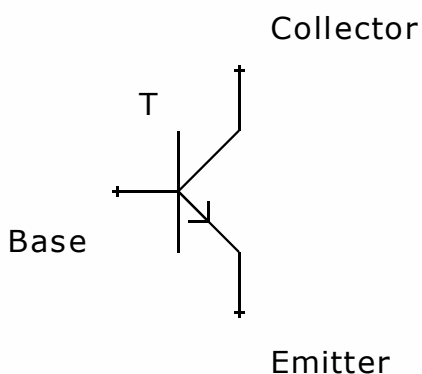

- The transistor type (NPN or PNP) can be changed in the transistor properties.
- β is the transistor current amplification.
 β notation and values can be changed in the properties.
When the transistor is functioning in linear mode the collector current intensity I_c is proportional to the base current intensity I_b : $I_c = \beta I_b$
- V_t is the threshold voltage of the base-emitter junction.
 V_t notation and value can be changed in the properties.
When the transistor is off, the base-emitter voltage has a value smaller than the threshold value.
When the transistor is on, this value is equal to the threshold value.

Meters

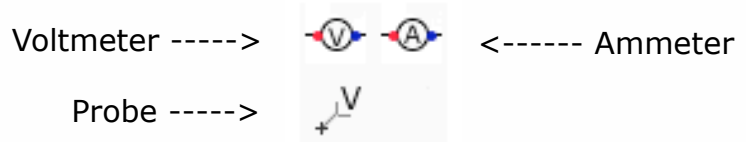

Use of meters

Each meter inserted in the circuit allow to define a notation for the quantity it measures. The quantities defined by meters are computed, their formulas and values are displayed in the solution. Those quantities can also be used to verify equations, draw graphs, etc ...

Meters representation

Ammeters and voltmeters can be represented as components connected to the circuit or as intensity or voltage arrows. The meters representation can be changed in Solve Elec preferences.

Voltmeter

- A voltmeter has to be connected between two points of the circuit, it measures the voltage across its terminals.
- The voltmeter is considered as an ideal instrument and is equivalent to a switch off : the current intensity through the voltmeter is zero.
- Example : measuring the voltage across a resistor

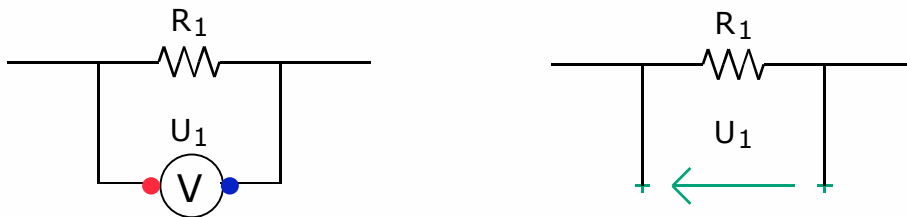

U1 is the voltage measured by the voltmeter.

Ammeter

- An ammeter has to be connected in serial, it measures the current intensity flowing through itself.
- The ammeter is considered as an ideal instrument and is equivalent to a switch on : the voltage across the ammeter terminals is zero.
- Example : measuring the current intensity flowing through a resistor



I1 is the intensity measured by the ammeter

Probe

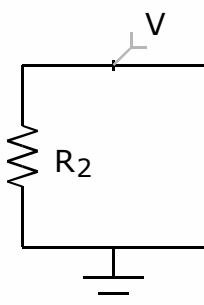

A probe can be connected on a wire or a component terminal. The probe measure the potentiel of the point where it is connected. The ground is the potentiels reference. A circuit containing a probe must also contain a ground.

Ground



- The ground is the potential reference : the potential of the point of the ground is 0 V.
- A ground can be inserted on a wire or a component terminal.
- A circuit may contain several grounds, the points where are those grounds are considered as connected, even if there is no wire between them.
- A circuit containing an amplifier or a probe must contain a ground.

Points

A

+

- You can set names to points of the circuit by inserting a point label on a wire or a component terminal.
- The points names are displayed in the circuit properties and they can be changed.
- Two different points must have different names.

Wires

- The wires connect components terminals.
- By default two crossing wires have no electrical contact.
- Choose contact tool and click the intersection point of two wires to add or remove a contact

Formulas

You can define new quantities related to the circuit by their formulas. For instance you can define the power dissipated by a resistor by the formula $P = U I$. The quantities defined by a formula are computed when the circuit is solved and they can be used like any other quantity defined by a meter

Formulas tool



- The formula tool is in the top of the Solve Elec window.
- Click this button to show formulas list.

Formulas list

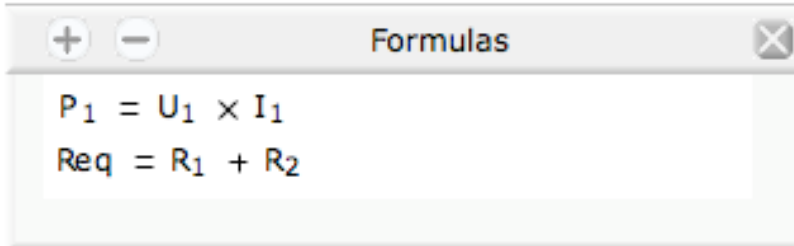

Formulas example

- Click button + to add a new formula.
- Click a formula to select it.
- Double click a formula to modify it.
- Select a formula and click it to suppress it.

Defining a formula

The formula definition window is displayed by clicking button + or by double clicking a formula in the list.

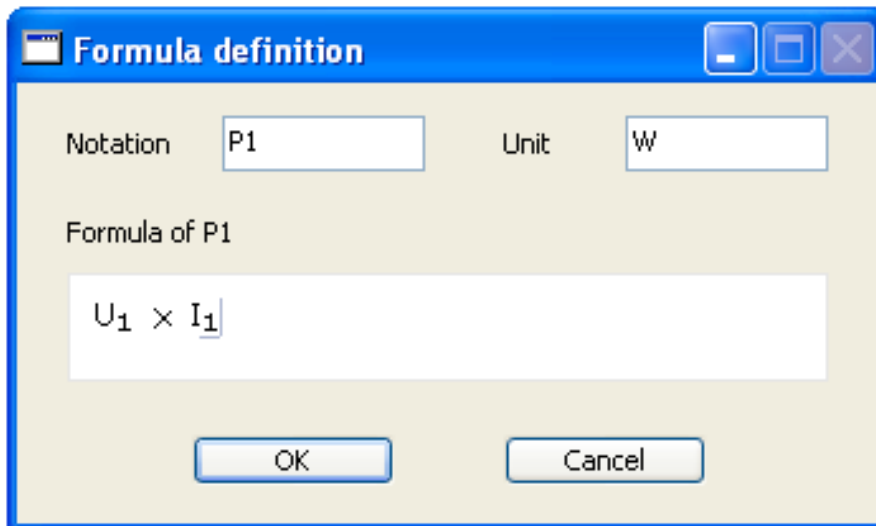

Example of the definition of the power P1

- The new quantity notation should not be already used for the circuit.
- The notations used in the formula can be any notation defined for the circuit
- The formula is edited with the keyboard : you can type lower or upper case letters, digits, operators (keys + - * / ^), parentheses.
- Use the keyboard arrows to move the cursor inside the formula.
- Use the mouse to place the cursor or to select a part of the formula.

Using formulas

The quantities defined by a formula are verified and computed when the circuit is solved. If the formula contains a undefined notation or if the formula of the quantity is incorrect, the quantity is not computed.

- The correctly defined quantities are displayed in the solution.
- Those quantities can be used in equations verification.
- Those quantities can be used to draw graphs.

Example : You define the power dissipated by the resistor R1 in the circuit below by the formula $P1 = U1 \cdot I1$ (see previous page). Then you can draw the graph of the power P1 versus R1.

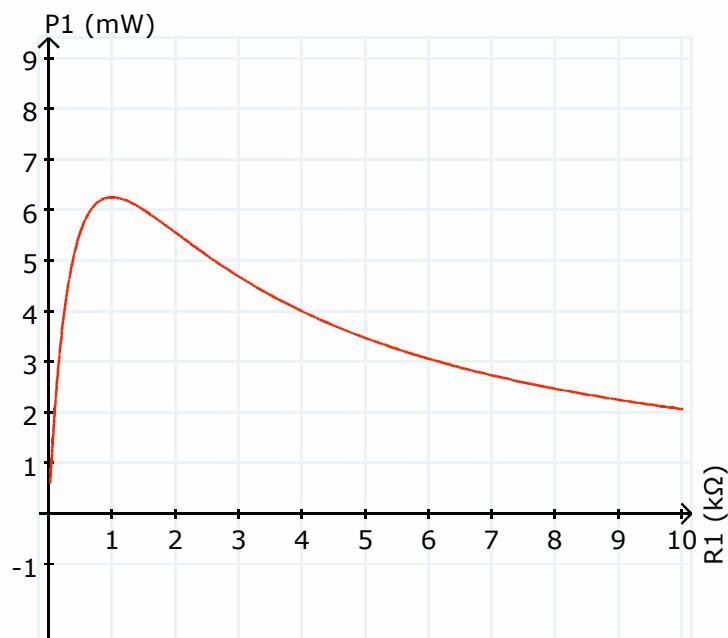
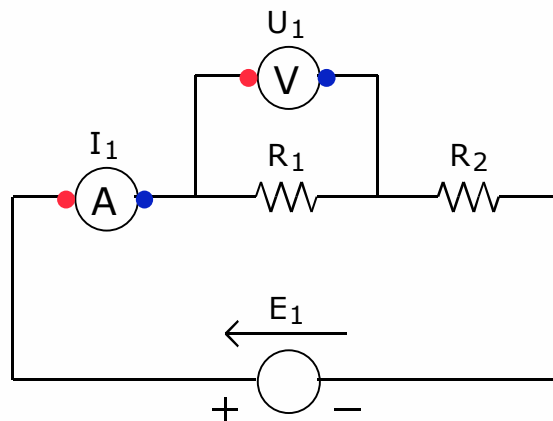

Solution

Displaying the solution



When the circuit drawing is done, click the Solution button to display the solution.

The solution indicates :

- whether the circuit is solved or not
- for a circuit containing components functioning in different states, the state of each of those components
- the formulas and values of voltages, current intensities, potentials and user defined quantities.

Switching the circuit

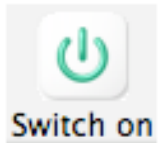

When this button is displayed, the circuit is off, the solution is not computed.

Click this button to switch the circuit on.

- if the circuit is correct, the solution is computed and the display is updated for the new solution. The circuit becomes on, the button Switch on becomes Switch off
- if the circuit is not correct, it remains off.

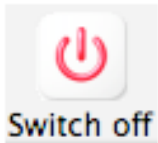

When this button is displayed, the circuit is on, the solution is computed.

You can switch the circuit off by clicking this button, the solution is no longer available.

Solution computation

- When the circuit is off, the solution is computed when one of the buttons Switch on, Solution, Equations or Graph is clicked. If a solution is found, the circuit is switched on.
- The circuit is automatically switched off after a circuit drawing modification, as the solution is no longer valid.
- Solve Elec computes the solution by the mean of a formal calculus engine : literal formulas of intensities and potentials are first computed, then the numerical values are computed using the literal formulas. The circuit is solved with the Kirchhoff method.
- The computation time might be long for a complex circuit. In such a case, a wait window is displayed, it is then possible to stop the computation by clicking the stop button of this window.

Equations

With Solve elec you can verify if an equation related to the circuit is correct or not.

Example

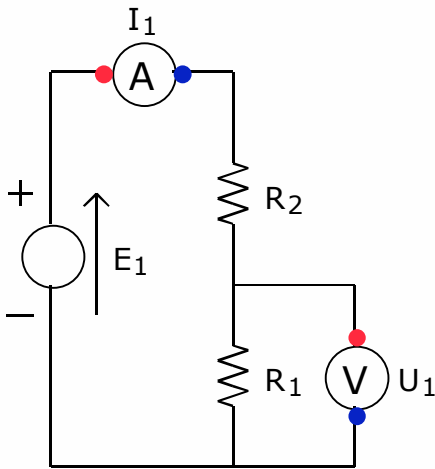

- You draw this circuit

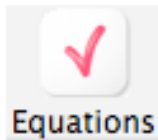

- Then you click the button Equations to display the equation inspector

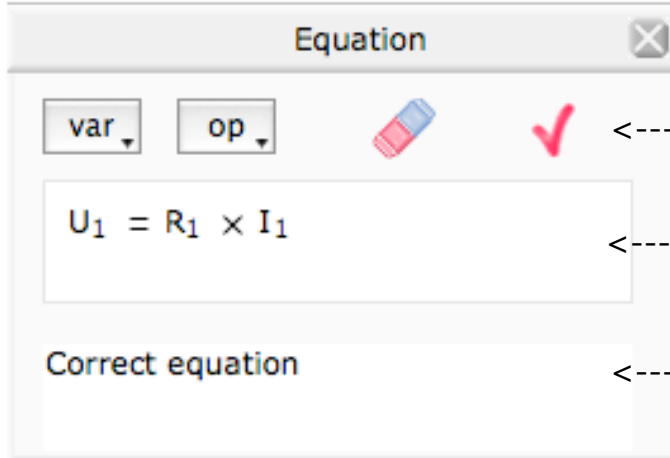

Click this button to verify the equation

Type the equation to be verified in this field

This field displays the result of the verification.

Editing an equation

With the keyboard

- You can type the equation in the equation field. For the previous example, you type the text $U_1=R_1*I_1$
- The typed characters are inserted after the cursor.
- Use the keyboard arrows to move the cursor inside the equation.
- Use the delete key to suppress the character before the cursor.

With the mouse

- Click inside the equation to set the cursor at this position.
- Drag the mouse over a part of the equation to select this part.

Other tools



- Click button var to display the list of available notations for the equation.
- Click one of those notations to insert it after the current cursor position.

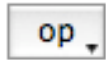

- Click button op to display the list of available operators for the equation.
- Click one of those operators to insert it after the current cursor position.



- Click the eraser to erase the whole equation.

Equation verification

- It is possible to verify an equation only if the circuit is on. The circuit drawing has to be correct.
- The notations used in an equation must be displayed in the drawing or in the circuit properties list. Those notations are displayed and can be selected by clicking the button var.
- An equation must contain the sign =

Solve Elec considers as correct an equation if :

- the equation is the result of applying general laws to the circuit (Kirchhoff's current and voltage laws)
- or the equation is related to a component, for instance Ohm law applied to a resistor
- or the equation is an algebraic combination of previous equations

When verifying an equation, Solve Elec can find following errors :

- error in signs
- non homogeneous equations (incorrect equations for the quantities units)
- incorrect application of Kirchhoff's current or voltage law

Graphs

Graph plotter

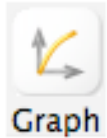

- Click the Graph button to display the graph plotter.
- If the circuit is off, the solution is computed and the circuit is switched on for a correct drawing.

The graph plotter can draw graphs for quantities defined for the circuit or by a formula.

Example :

You draw an amplifier circuit :

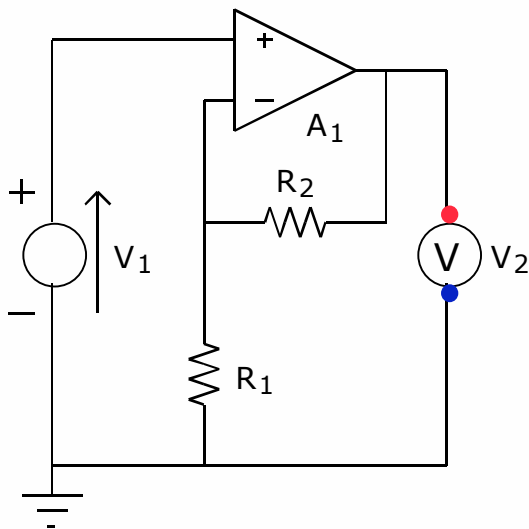

$R1 = 1,00 \text{ k}\Omega$
 $R2 = 1,00 \text{ k}\Omega$
 $V1 = 5,00 \text{ V}$
 $A1 \text{ VsatH} = 15,0 \text{ V} \text{ VsatL} = -15,0 \text{ V}$
 $V2$

You draw the graph of the output voltage $V2$ versus the input voltage $V1$

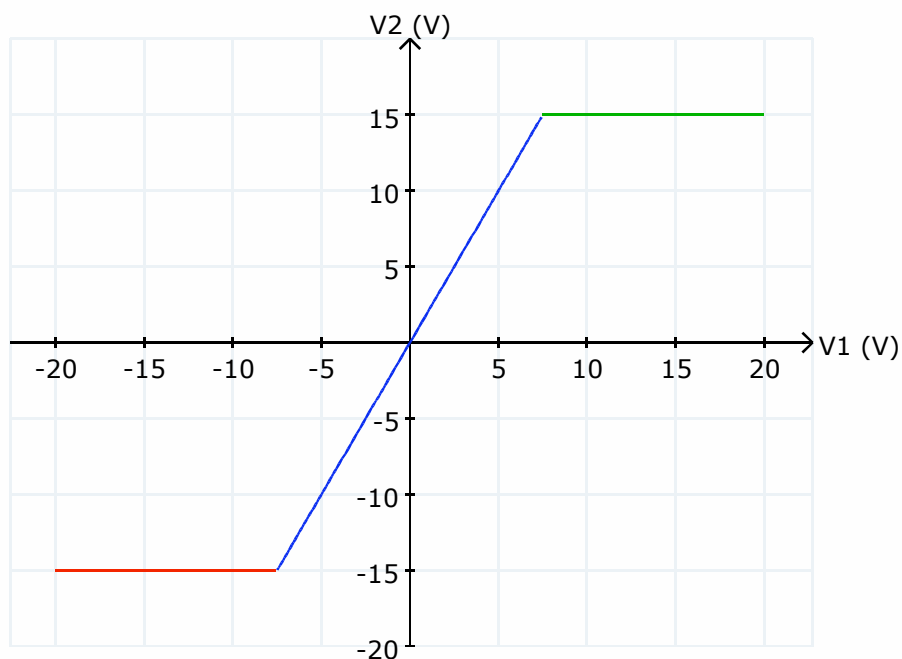

You can modify the graph position, the axis scales, display points coordinates and graph legend.

Axis definition

Selecting axis

- The horizontal axis quantity notation is displayed at right of the axis. If no quantity has already been selected, a question mark is displayed instead. Likewise the vertical axis quantity notation or a question mark is displayed on top of the axis.

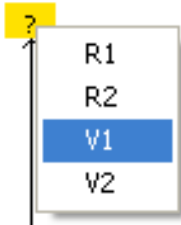

- To select an axis, move the mouse over the axis notation (or a question mark). The notation becomes highlighted. Click inside the yellow rectangle, a selection menu is displayed, click the desired notation in this menu.

Usable quantities

The notations of usable quantities for an axis are displayed in the axis menus.

- quantities associated to components :

Examples : resistance, voltage source electromotive force

- quantities defined by meters : intensity measured by an ammeter, voltage measured by a voltmeter, potentiel measured by a probe

- quantities defined by a formula.

Graph parameter

- If the both axis quantities are defined by a meter or a formula, a parameter must be selected. The parameter value will be changed to get a set of points of the graph.

A graph parameter is chosen among quantities associated to components.

Example :

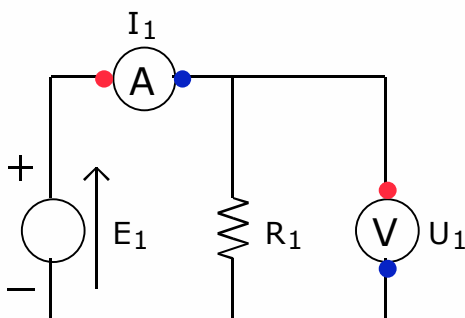

To draw the graph of the voltage U_1 across the resistor R_1 versus the intensity I_1 flowing through the resistor, one change the electromotive force of the source E_1 . E_1 is the graph parameter.

- Selecting a parameter :



The parameter is displayed above the graph. Move the mouse over the question mark and click inside the yellow rectangle to display parameters menu, then click the desired parameter.

Graph definition

You can define a graph by selecting its axis one after the other as described in previous page or you can open the graph definition window to define both axis.



Click the graph definition button to show the graph definition window.

For each axis :

- click the button notation to select the axis quantity.
- when the axis notation is selected, the default minimum and maximum values for the selected notation are displayed. You can change those values as well as their units.
- click button OK to draw the graph.

It is not possible to define a new graph when the cursor coordinates or the legend is displayed, they must be hidden first by clicking the associated button (cf. next page)

Editing a graph

The displayed graph can be modified if the cursor coordinates and the legend are hidden. You can change axis notations, axis scales and graph position and grid

Shifting the graph

Drag the graph with the mouse to shift it inside its frame. The graph is drawn at its new location without changing the axis scales.

Changing axis scale

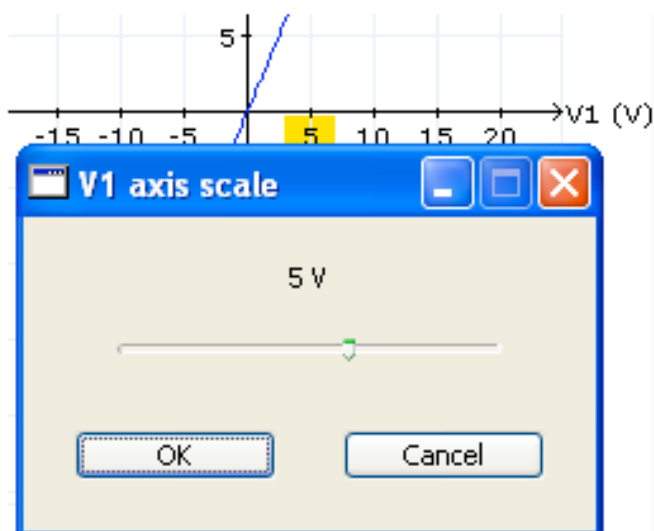

- Move the mouse to the first axis graduation mark after the graph origin. The mark becomes highlighted in yellow.

- Click the yellow rectangle to display the scale selection window.

- Move the cursor to change the scale.

- Click button OK to validate the change.

Grid

Select Preferences menu to hide or show the grid and change grid lines color.

Cursor coordinates



- Click the button Cursor coordinates to display the coordinates of the cursor, then move the cursor inside the graph frame. The button remains on.

- Click a point inside the graph frame to write its coordinates on the graph.
- Click a point coordinates to erase them.
- Click the button Cursor coordinates to hide cursor coordinates and erase written point coordinates. The button becomes off.
- It is not possible to change the graph (scales, axis or position) when the cursor coordinates are displayed.

Legend

The graph legend is available for circuits functioning in different states. The curve is drawn using different colors, each color representing a state of the circuit. The legend shows the description of the state for each color.

Example :

The amplifier A1 may function in 3 different states : linear mode, high or low saturation as displayed in the legend.

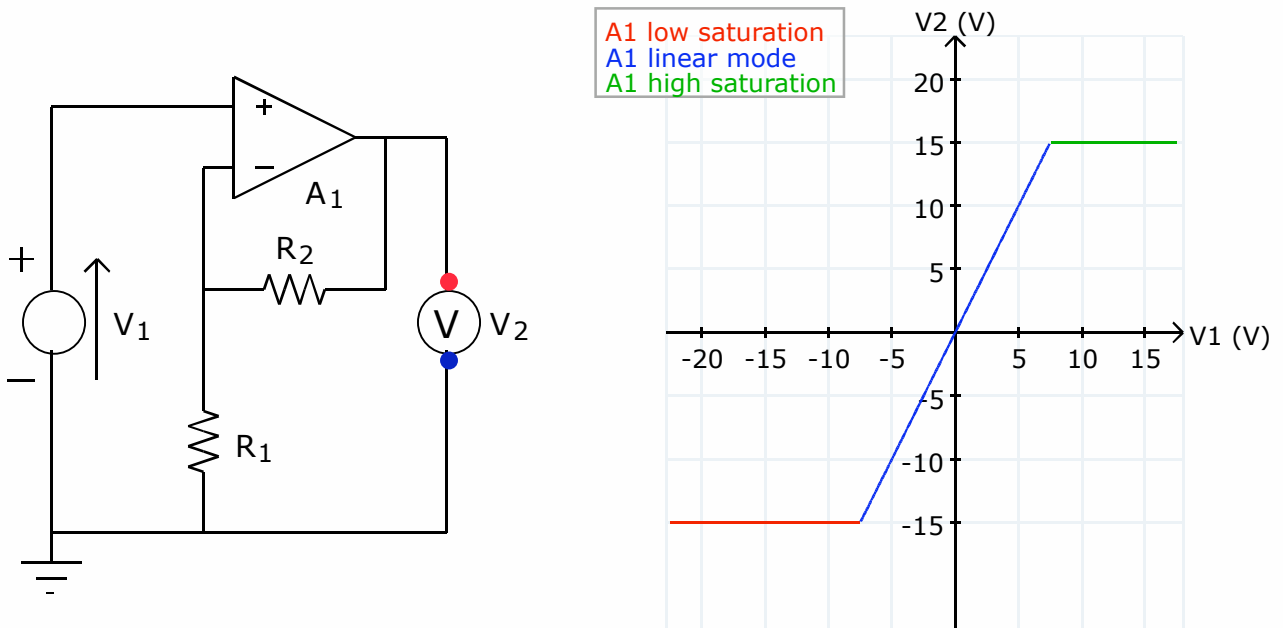

Displaying and positioning the legend



- Click the legend button. The legend is displayed at the right top of the graph frame. You can then drag it to another position.
- The legend is not displayed for a circuit with only one state.
- The graph can't be modified when the legend is displayed.

Hiding the legend

- Click the legend button. The legend disappears, the graph can be modified again.

Equivalent circuit

With Solve Elec, you can get the equivalent circuit to any linear circuit as seen from two terminals, as well as the formulas of the equivalent circuit components.

For instance, you can get the formula of the equivalent resistance of resistors combination or in case of a circuit containing a source you can get the Thevenin or Norton equivalent circuits.

Circuit drawing

Draw the circuit and add point names on the two circuit terminals.

Example :

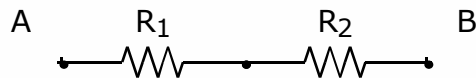

The analyzed circuits are combinations of linear components : resistors, potentiometers, sources, meters, amplifiers (only if functioning in linear mode). It is not possible to find an equivalent circuit of a combination containing a diode or a transistor, which are not linear.

Equivalent circuit display

Equivalent circuit tool



Click this button to show the equivalent circuit display.

Choosing circuit terminals

In case there are more than two point names on wires or components terminals in the displayed circuit, you can get the equivalent circuit as seen from any two of those points : choose the circuit's terminals with the terminals menus.

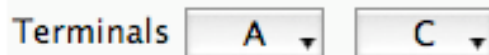

Computing equivalent circuit



Click this button to get the equivalent circuit and its formulas

Thevenin and Norton equivalent circuit

If the circuit contains a source, the equivalent circuit can be drawn as a Thevenin circuit or a Norton circuit

N

Click the button N to display the Norton circuit

T

Click the button T to display the Thevenin circuit

Report

- A report is made of various elements displayed in Solve Elec main window : for instance, you can insert in a report graphical elements like the circuit drawing or a part of it, graphs, formulas displayed in the solution and circuit properties. It possible also to add editable text fields and images from other applications. The documentation you are reading now is a report made with Solve Elec.
- A report is divided in one or more pages, it may contain a plan.
- You can save and print any report.

Report menu

New report

Select the menu Report > New report to create a new empty report, with one page.

Open a report

Select the menu Report > Open report to display a previously saved report.

Save a report

Select the menu Report > Save report or Report > Save report as ... to save the displayed report.

Reports files are independant from the circuit files saved by using the file menu. In particular, circuit drawing datas are not saved in report files

Print

Select the menu Report > Print to print the report. Printed pages are identical to displayed pages.

Add a new page

Select the menu Report > Add a new page to insert a new page in the report. the new page is added after the current page.

Remove current page

Select the menu Report > Remove current page. The current page and its content are removed from the report.

Browsing a report

Displaying a page

Click this button to display previous page ----->

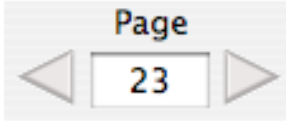

<----- Click this button to display next page

↑
Displayed page number.
Type in another number and validate to display another page

Using the report plan



Click this button to show or hide the plan.
The plan is displayed at the left of current page.

Click a title in the plan to display the page containing this title.

Editing a report

Edition tools

Graphical elements edition and selection



You can select and edit graphical elements when this button is on.
Click this button to switch it on or off.

Editing text



You can insert and edit text fields when this button is on.
Click this button to switch it on or off.

Formats



Click this button to show the formats window. This window can't be opened while editing text.

The formats are applied to the current page or a selected graphical element or a text field. Text formats are applied to the whole text of the selected field

Inserting graphical elements

In order to insert graphical elements displayed in main window, click selection button in the upper tool bar of the report to switch it on.

Drawing

- Select a part of the drawing
- Press alt key and drag the selection to the displayed report page.
- Or copy the selection in the clipboard, click inside the report page and paste the selection.

Circuit properties

Insertion of all the properties of a circuit in a report :

- Click one of the properties.
- Press alt key and drag all the properties to the displayed report page.

Insertion of the properties of one component in a report :

- Click the component properties.
- Copy the properties in the clipboard.
- Click inside the report page and paste the component properties.

The properties inserted in a report are displayed as graphical elements, their text can't be edited in the report.

Graph

- Click the graph.
- Press alt key and drag the selection to the displayed report page.
- Or select the menu Copy graph, then click the report page and paste the graph.

Solution and equivalent circuit

- Select one or more elements displayed in the solution.
- Press option key and drag the selection to the displayed report page.
- Or copy those elements, then click the report page and paste them.

The solution elements inserted in a report are displayed as graphical elements, their text can't be edited in the report.

Image

You can insert an image which has been previously copied in the clipboard from another application by using the menu Edit > Paste image.

You can also drag an image from another application, if it supports drag and drop.

Inserting and editing text

Choose text tool (A) in upper tool bar of the report

- Click at an empty position to insert a new text field and type the text.
- Click an existing text field to edit it.

In text mode it is possible to select text with the mouse, copy the selected text and paste text from the clipboard

All characters of a text field are displayed with the same format (font, font size, color, etc ...)

In order to change a text field format :

- Choose select tool
- Click the text field to select it
- Click format button in upper tool bar of the report
- Choose the format of the text in the formats window.

Selecting elements

- Choose select tool in upper tool bar of the report
- Click an element to select it
- Click other elements while pressing shift key to add those elements to the selection or drag the mouse over the elements to be selected.

Moving elements

Select the elements you want to move and drag them to the desired position. The dragged elements remain inside the current page.

Selected elements can be moved also by using the keyboard arrows keys

Changing graphics scale.

Select a graphical element and drag one of its corners.

Changing text fields dimensions

Select a text field and drag one of its corners. The field dimensions are changed but the text format is unchanged.

Editing report plan

Plan display



Click this button to show or hide the report plan.
The plan is displayed at the left of the current page. It contains titles at different levels.

Adding titles to the plan

- Type the title in a text field.
- Choose select tool, select the title.
- Click format button to display the formats window.
- Check the button Title in the formats window

The title is then automatically added to the plan.

To suppress the title from the plan, uncheck the button Title